



# SURESHOT ARMAMENT GROUP

## Product catalog





# COMPANY INFO

We're those guys doing crazy AK and DRAGUNOV stuff since 2014.

We are extremely passionate about our work with AKs and SVDs and strive to maximize weapon performance. SAG products are not only actively used in MIL/LE but also widely adopted by AK and SVD enthusiasts around the globe.

## COMPANY PRINCIPLES

- ▶ HIGH QUALITY
- ▶ CUSTOMER FIRST
- ▶ INNOVATION
- ▶ TECHNOLOGICAL LEADERSHIP





# PRODUCTS

## KALASHNIKOV AND DRAGUNOV UPGRADES

▶ HANDGUARDS ▶ p. 8

▶ SIDEMOUNTS ▶ p. 10

▶ CHASSIS ▶ p. 12

▶ BUTTSTOCKS / M-LOK AND KEYMOD ACCESSORIES ▶ p. 14





# KALASHNIKOV UPGRADES

## AK MK2.1 CHASSIS

- ▶ SVAROG (mono 1913-MIL-STD)
- ▶ M-LOK handguard top
- ▶ 1913-MIL-STD handguard top

## AK MK3 CHASSIS

- ▶ Monolythic 1913-MIL-STD top, short handguard
- ▶ 1913-MIL-STD TOP with RSB, MK2.1 handguard
- ▶ 1913-MIL-STD TOP with RSB, short handguard
- ▶ 1913-MIL-STD TOP with RSB, long handguard



## BUTTSTOCKS

- ▶ AR buttstock adapter
- ▶ Adjustable buttstock with adapter

▶ AK47 / VP0136 / VP0209 / VEPR

▶ AK74 / AK100 / SAIGA9 / SAIGA308

▶ VITYAZ / SAIGA9 / TR9

▶ AK47 / VP0136 / VP0209

▶ AK74 / AK100 / SAIGA / SAIGA308

▶ VITYAZ / SAIGA9 / TR9

▶ GALIL / VALMET

## OPTICAL SIDEMOUNTS

▶ 1913-MIL-STD / ACOG, 0MOA, BIT

▶ 1913-MIL-STD / ACOG, 0MOA, AK-ACOG

▶ 1913-MIL-STD / ACOG, 0MOA, AK-ACOG, QD



## AK MK1 HANDGUARDS

▶ MK1 3 M-LOK with slot

▶ MK1 4 M-LOK with slot

▶ MK1 5 M-LOK with slot

▶ MK1 5 M-LOK w/o slot

▶ MK1 7 M-LOK with slot

▶ MK1 7 M-LOK with insert

▶ MK1 7 M-LOK with slot and insert

## M-LOK ACCESSORIES

▶ 3 slot rail section

▶ 5 slot rail section

▶ QD sling swivel mount

▶ HARRIS adapter



# DRAGUNOV UPGRADES

## SVD MK1 CHASSIS

- ▶ 1913-MIL-STD 20MOA, Keymod
- ▶ 1913-MIL-STD 20MOA, M-LOK



## M-LOK ACCESSORIES

- ▶ 3 slot rail section
- ▶ 5 slot rail section
- ▶ QD sling swivel mount
- ▶ HARRIS adapter

## KEYMOD ACCESSORIES

- ▶ 5 slot rail section



▶ SVDS

▶ SVDM

▶ TIGER folding

## BUTTSTOCKS

▶ Adjustable buttstock with adapter

▶ AR buttstock adapter









## OPTICAL SIDEMOUNTS

▶ 1913-MIL-STD, 20MOA, SVD-LOW

▶ 1913-MIL-STD, 20MOA, SVD-HIGH



# HANDGUARDS

	Name	Vendor code	Application
	<b>MK1 3M-LOK</b> with slot	S20022	VITYAZ / SAIGA9 / TR9
	<b>MK1 4M-LOK</b> with slot	S20001	AK / SAIGA
	<b>MK1 5M-LOK</b> with slot	S20002	AK / SAIGA
		S20003	AK / SAIGA308
		S20004	VPO
	w/o slot	S20044	AK / SAIGA308
		S20034	AK / SAIGA
	<b>MK1 7M-LOK</b> w/o slot	S20027	VITYAZ / SAIGA9 / TR9
		S20045	VITYAZ / SAIGA9 / TR9
	with slot with insert	S20023	AK / SAIGA
		S20041	AK / SAIGA
		S20043	SAIGA308





## KEY ADVANTAGES OF SAG HANDGUARDS

- ▶ Easy installation.
- ▶ Freefloat the handguard which gives Point Of Impact (POI) stability regardless barrel heating during shot strings.
- ▶ Significantly improve rifle ergonomics: users enjoy comfortable hand placement due to sufficient handguard length.
- ▶ Do not increase weight when mounted on carbines relative to a basic carbine with handguards of similar length.
- ▶ Use the widely adopted M-LOK interface for additional accessories.





## OPTICAL SIDEMOUNTS

	Name	Vendor code	Application
	1913-MIL-STD/ACOG, 0MOA, BIT	S20019	
	1913-MIL-STD/ACOG, 0MOA, AK-ACOG	S20016	AK74 / AK100 / SAIGA / SAIGA308 / VEPR / RPK
	1913-MIL-STD/ACOG, 0MOA, AK-ACOG, QD	S20018	
	1913-MIL-STD, 20MOA, SVD-LOW	S20021	SVD / TIGER / SVDS / VSS
	1913-MIL-STD, 20MOA, SVD-HIGH	S20020	SVD / TIGER / SVDS / VSS / SVDM

## KEY ADVANTAGES OF SAG SIDEMOUNTS



- ▶ High-precision CNC milled from aircraft-grade aluminum alloy.
- ▶ All clamping elements and fasteners are made of hardened steel.
- ▶ The light weight allows you to have a stable base for the optics without worrying about drastic changes in the weight and balance of the weapon.
- ▶ Built-in ACOG interface (for AK sidemounts) and a 20MOA cant (for SVD sidemounts) allow the user to select optics fit for the task.
- ▶ All sidemounts (except SVD-LOW) allow users to disassemble/reassemble weapons for cleaning with no need for sidemount removal.





# CHASSIS

CHASSIS = HANDGUARD + OPTICAL SIDEMOUNT

	Name	Vendor code	Application
	<b>Chassis MK2.1</b> SVAROG (mono 1913-MIL-STD)	S20017	AK47 / VPO136 / VPO209 / SAIGA short / AK100 / SAIGA full-size
	M-LOK handguard top	S20012	
	1913-MIL-STD handguard top	S20011	
	<b>Chassis MK3</b> Monolithic 1913-MIL-STD top, short handguard	S20048	AK47 / VPO136 / VPO209 / SAIGA short / AK100 / SAIGA full-size
	1913-MIL-STD top with RSB, MK2.1 handguard	S20053	
	1913-MIL-STD top with RSB, short handguard	S20050	
	1913-MIL-STD top with RSB, long handguard	S20049	AK47 / AK74
	<b>Chassis MK1</b> 1913-MIL-STD 20MOA, Keymod	S20033	SVD / TIGER SVDS / SVDM / TIGER Foldable
	1913-MIL-STD 20MOA, M-LOK	S20051	







## KEY ADVANTAGES OF SAG CHASSIS

- ▶ Easy installation.
- ▶ Freefloat the handguard, which gives POI stability regardless of the heating of the barrel when firing. At the same time, the chassis serves as a basis for the installation of a wide range of optical sights.
- ▶ Significantly improve rifle ergonomics: users enjoy comfortable hand placement due to sufficient handguard length.
- ▶ Do not increase weight when mounted on carbines relative to the “basic carbine + side mount” combo.
- ▶ Use the widely adopted M-LOK interface for additional accessories.





## BUTTSTOCKS, M-LOK AND KEYMOD ACCESSORIES

	Name	Vendor code	Application
	<b>Buttstocks</b> AR buttstock adapter	S20009	AK100 / SAIGA / SAIGA308 / VITYAZ / SAIGA9
	Adjustable buttstock with adapter	S20056	AK100 / SAIGA / SAIGA308 / VITYAZ / SAIGA9
		S20036	SVD / TIGER
		S20037	SVDS / SVDM / TIGER folding
	AR buttstock adapter with steel base	S20058	SVDS / TIGER folding
		S20059	AK100 / SAIGA folding
		S20061	AK74 / AKSU
	<b>M-LOK and Keymod accessories</b> 3 slot rail section	S20031	M-LOK interface
	5 slot rail section	S20032	M-LOK interface
		S20030	Keymod interface
	QD adapter	S20013	M-LOK interface
	HARRIS adapter	S20014	M-LOK interface
		S20015	Keymod interface



## KEY ADVANTAGES OF SAG BUTTSTOCKS

- ▶ Easy installation.
- ▶ Precision CNC milled from the chunk of the extra strong aluminium alloy. All adjusting elements are made from steel.
- ▶ Minimal weight. Wide selection of possible adjustments.
- ▶ Compatible with M-LOK accessories (for adjustable buttstocks), built-in QD swivel bases.

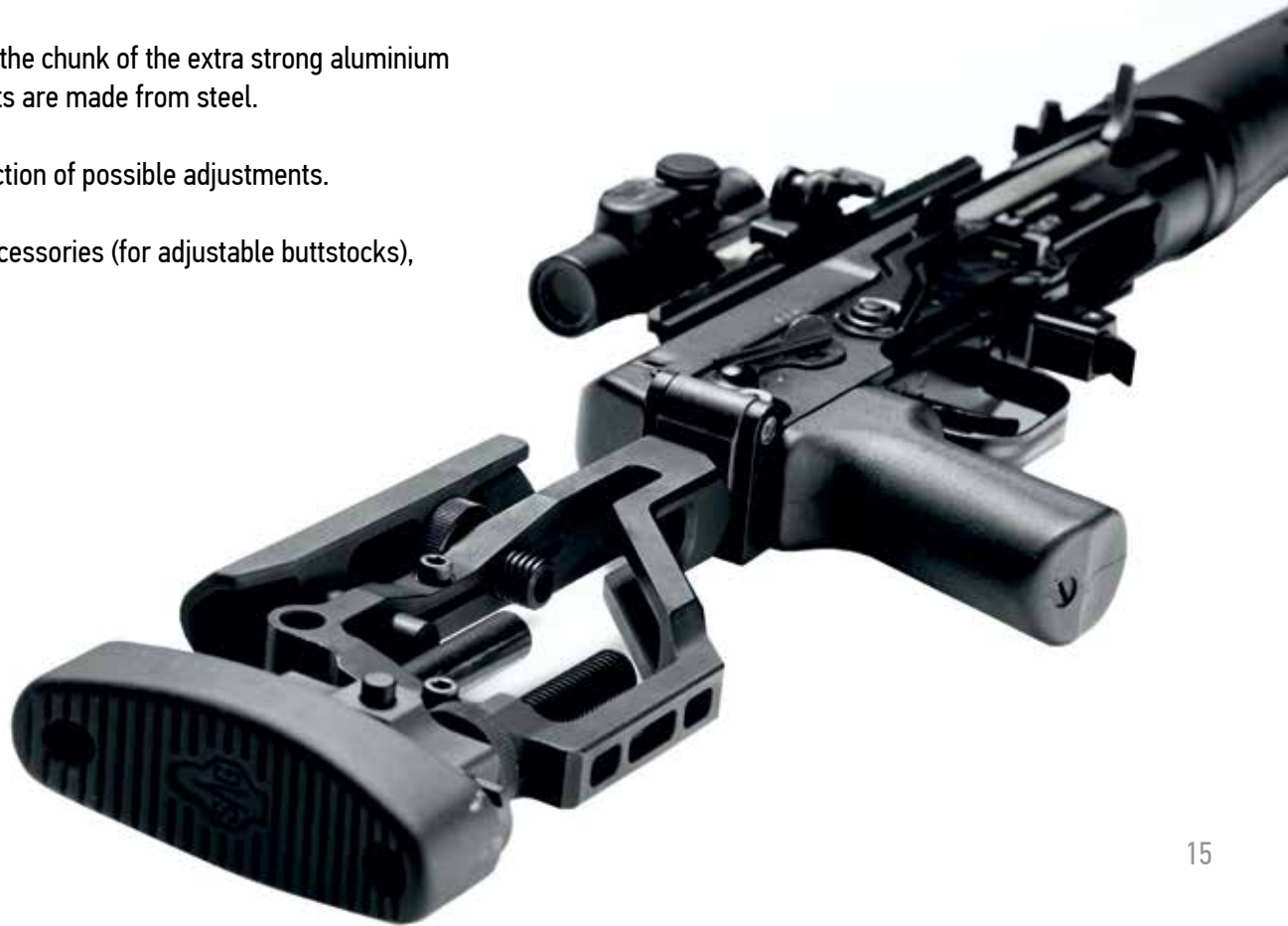

Bill Fan  
General Manager of SAG USA





## CUSTOMER CARE

SAG products are protected by valid warranties issued in accordance with local legislation.

If you bought any product and later changed your mind, simply return the product to the store to get your money back (provided that there is no mechanical damage). For example, you can do it within 14 days in Russia.

If the product sustained mechanical damage but you're adamant that the product "could have performed better," then contact SAG customer support to resolve the issue. We value customers' expectations from our products.

### USA

[www.sureshot-usa.com](http://www.sureshot-usa.com)

[info@sureshot-usa.com](mailto:info@sureshot-usa.com)

 @sureshot\_usa

### EMEA

[www.sureshot-armament.com](http://www.sureshot-armament.com)

[info@sureshot-armament.com](mailto:info@sureshot-armament.com)

 @sag\_ru

 @sureshotarmament



[www.sureshot-armament.com](http://www.sureshot-armament.com)  
[www.sureshot-usa.com](http://www.sureshot-usa.com)